

HEAT INTERFACE UNITS

 **TayTech®**
advanced automation solutions

www.taytech.com.tr

info@taytech.com.tr



Direct SmartHexa RH

1. General Description



SmartHexa RH delivers high efficiency with its advanced electronic control system while prioritizing domestic hot water (DHW) production.

The unit continuously monitors system parameters to ensure reliable and optimal performance. With its stainless steel heat exchanger and piping, it provides long-lasting durability and operates efficiently with radiator heating systems.

Thanks to its motorized control valve and intelligent control algorithms, SmartHexa RH ensures stable and precise hot water comfort. Optional outdoor compensation control enhances energy efficiency by adapting to changing ambient conditions.

Integrated smart features such as PC connectivity, return temperature control, anti-legionella function, and keep warm mode provide enhanced performance and user comfort.

All operational data can be transmitted to the BLES system for remote monitoring and control.

Features

- Fully electronic control with PC connectivity via GSM or Ethernet for easy setup and commissioning
- Fast and precise DHW control with calibrated sensors
- Return temperature control for district heating with a high-efficiency heat exchanger
- Smart anti-legionella function for safe domestic hot water
- Pump and valve exercise mode to prevent sticking and ensure reliable operation
- Compatible with radiator heating systems, ensuring reliable performance at higher temperature levels
- Proportional motorized control valve for precise temperature management

Direct SmartHexa RH

2. Hydraulic Review

2.1 Component List

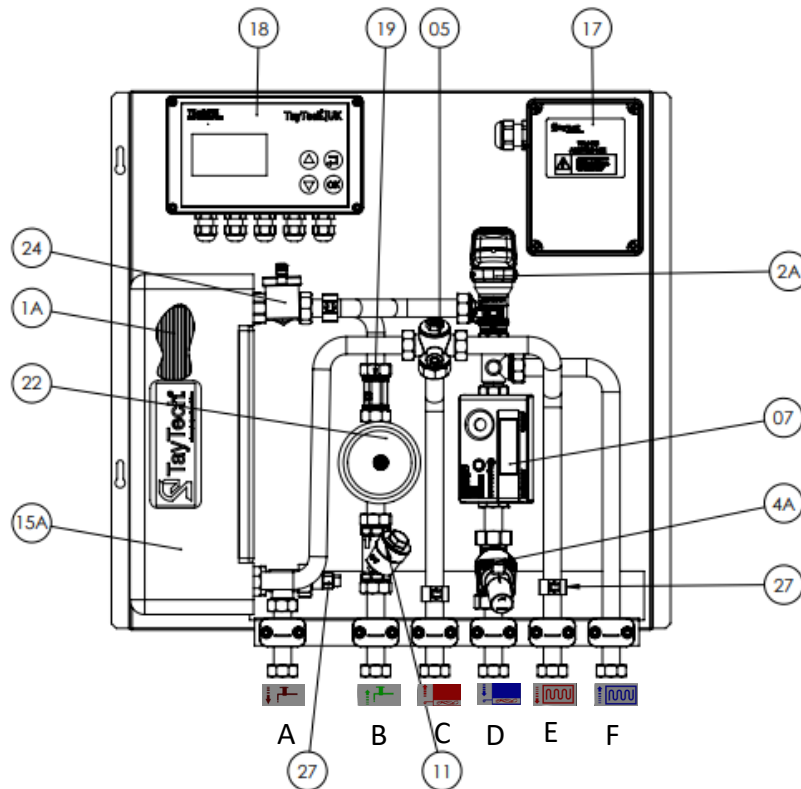

- | | |
|----------------------------------|--|
| 1A DHW Heat Exchanger | 17 Junction Box |
| 2A DHW Temperature Control Valve | 27.1 DHW Temperature Sensor |
| 5 District Heating Strainer | 27.2 DHW Return Temperature Sensor |
| 7 Heat Meter | 27.3 District Heating Temperature Sensor |
| 11 SH Strainer | 27.4 SH Return Temperature Sensor |
| 19 Flow Sensor | 27.5 SH Temperature Sensor |
| 22 Water Hammer Arrester | 18 TT LogicBOX Controller |
| 24 Automatic Air Vent | |

★ Direct SmartHexa RH

2. Dimensions

Back View

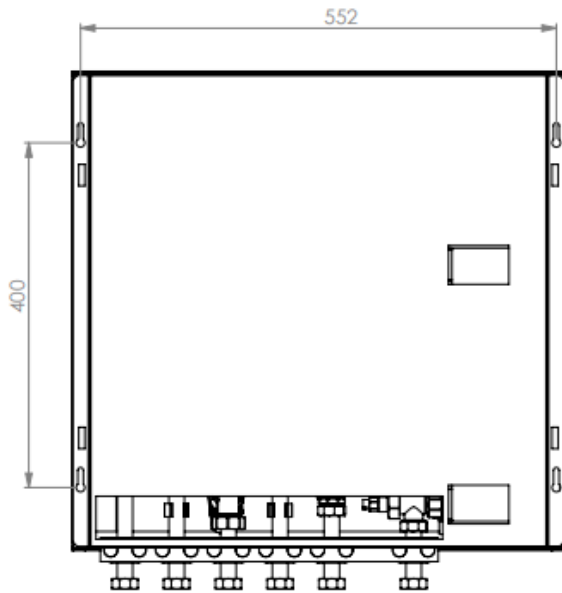

Front View

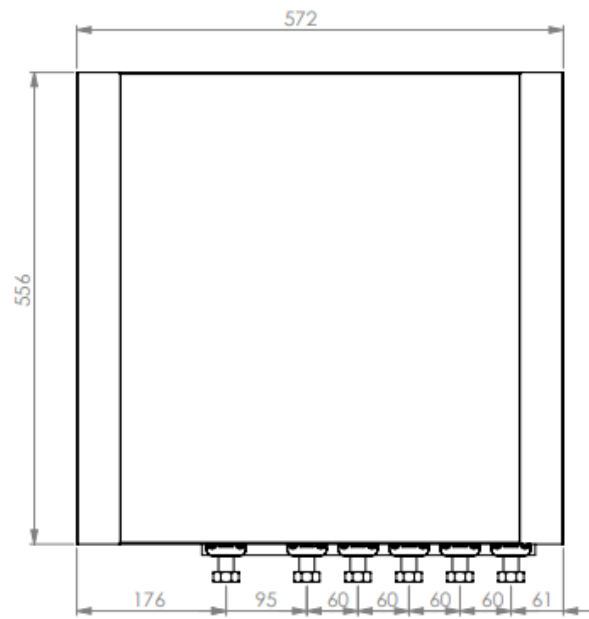

Wall Mounted View

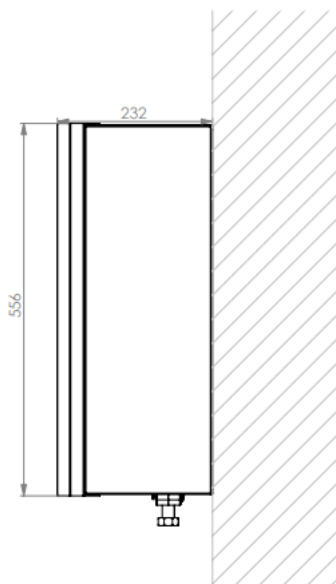

Bottom View

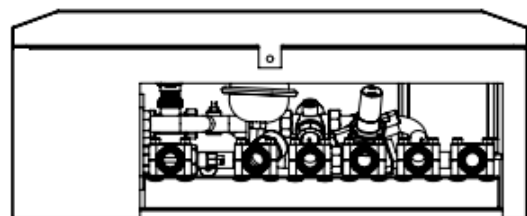

Direct SmartHexa RH

2. Hydraulic Review

2.2 Flow Diagram

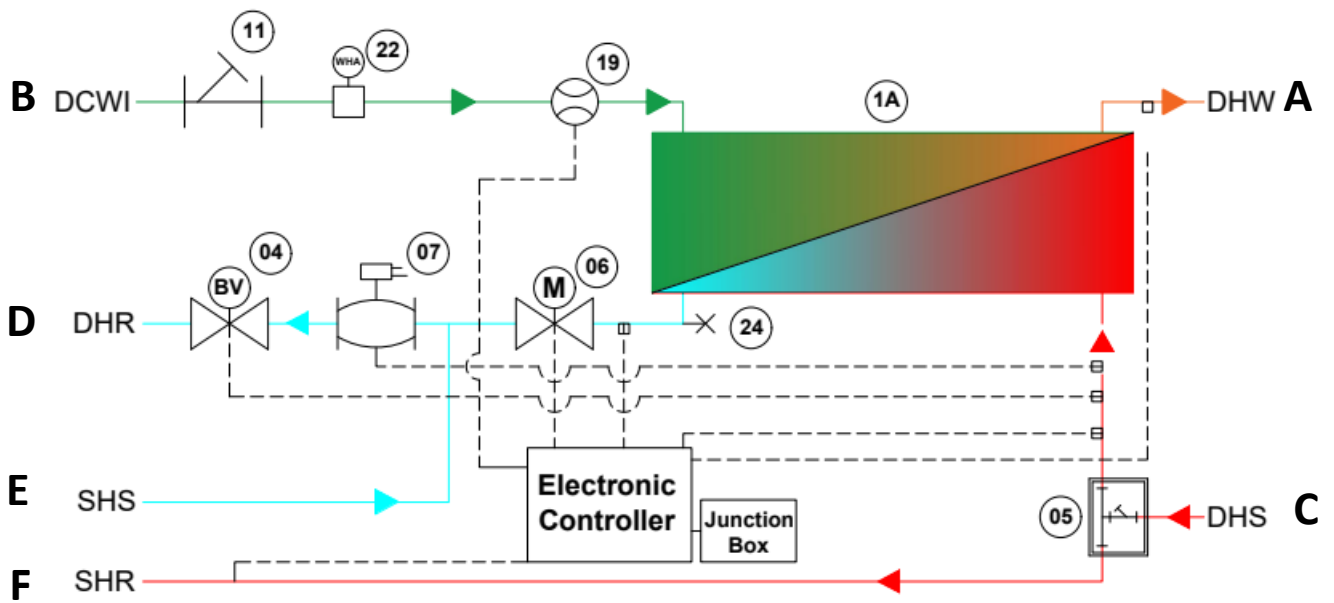

- A — DHW — Domestic Hot Water
- B — DCWI — Domestic Cold Water Inlet
- C — DHS — District Heating Supply
- D — DHR — District Heating Return
- E — SHS — Space Heating Supply
- F — SHR — Space Heating Return

Direct SmartHexa RH

3. Technical Specifications

Description	Data
Nominal primary supply temperature	70°C
Maximum primary supply temperature	85°C
Minimum primary supply temperature	55°C *
Nominal DHW supply temperature	55°C
DHW Set Range	45°C to 60°C
Return Temp Limit Range	35°C to 65°C
CH Limit Range	30°C to 80°C
Primary connections	Female / 18mm
Mains & DHW connections	Female / 18mm
Central heating connections	Female / 18mm
Pressure relief	15mm
Maximal primary differential pressure (without dP regulator)	450kPa
Pressure class DH circuit	PN16
Pressure class CH circuit (3 bar safety valve)	PN3
Pressure class DHW circuit	PN10
SH Maximum working pressure	2.5 Bar
Casing width	572mm
Casing height	556mm
Casing depth	232mm
Casing Material	Metal case with Insulation
Weight	35kg **
Electrical supply info	230V 50Hz
Fuse ratings	3 Amp
Sensor DHW	NTC 10k ohm @ 25°C
Functions	Keep Warm Legionella Pump Exercise Valve Exercise Pre-pay Shut Off Hot Water Priority Primary Return Temperature

* Minimum required DH supply temperature is DHW setpoint + 5°C with a minimum of 55°C.

** Unit weight may vary depending on the optional components built into the unit.

Direct SmartHexa RH

4. Performance Curves

4.1 District Heating Flow Rates (Capacity 1)

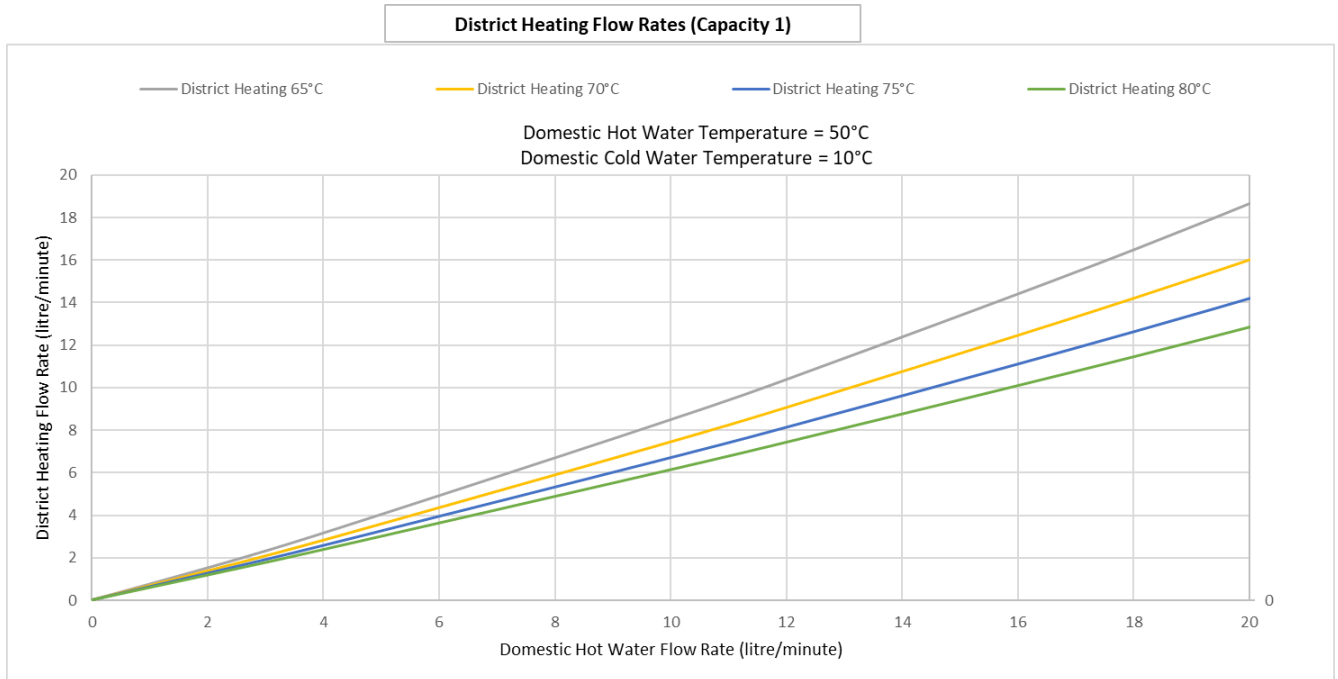

4.2 District Heating Return Temperatures (Capacity 1)

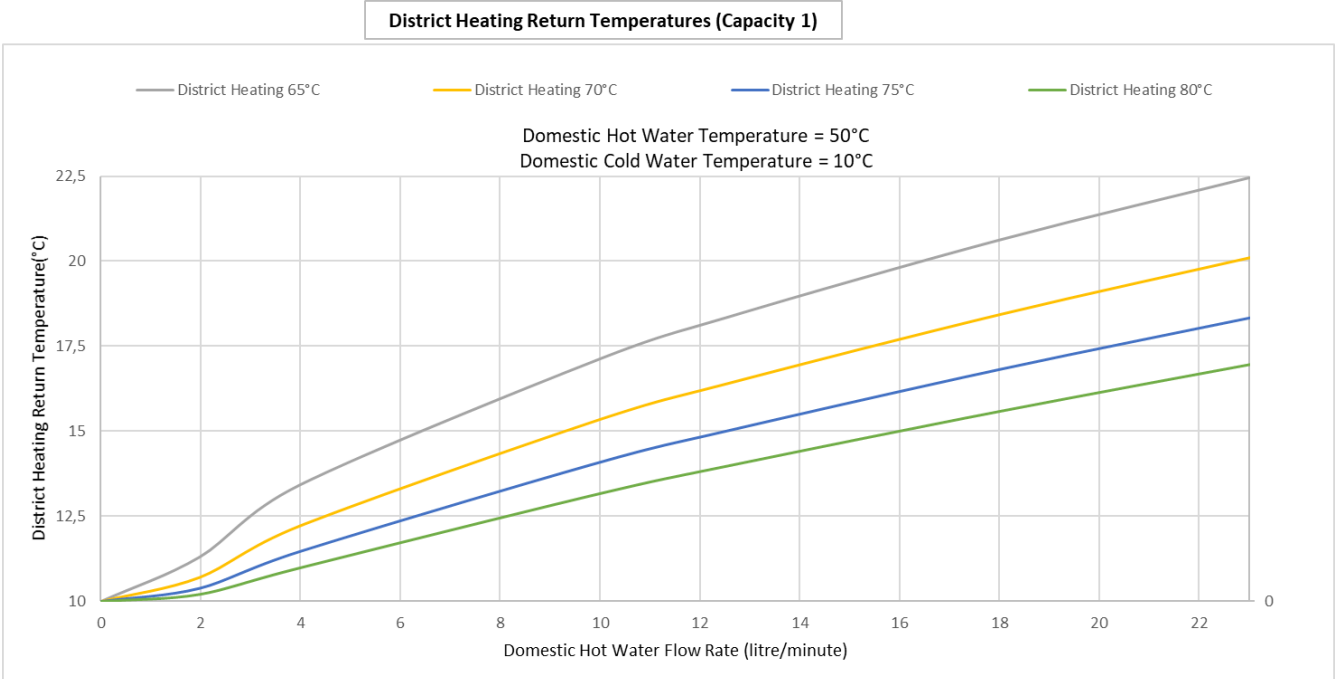

Direct SmartHexa RH

4. Performance Curves

4.3 District Heating Flow Rates (Capacity 2)

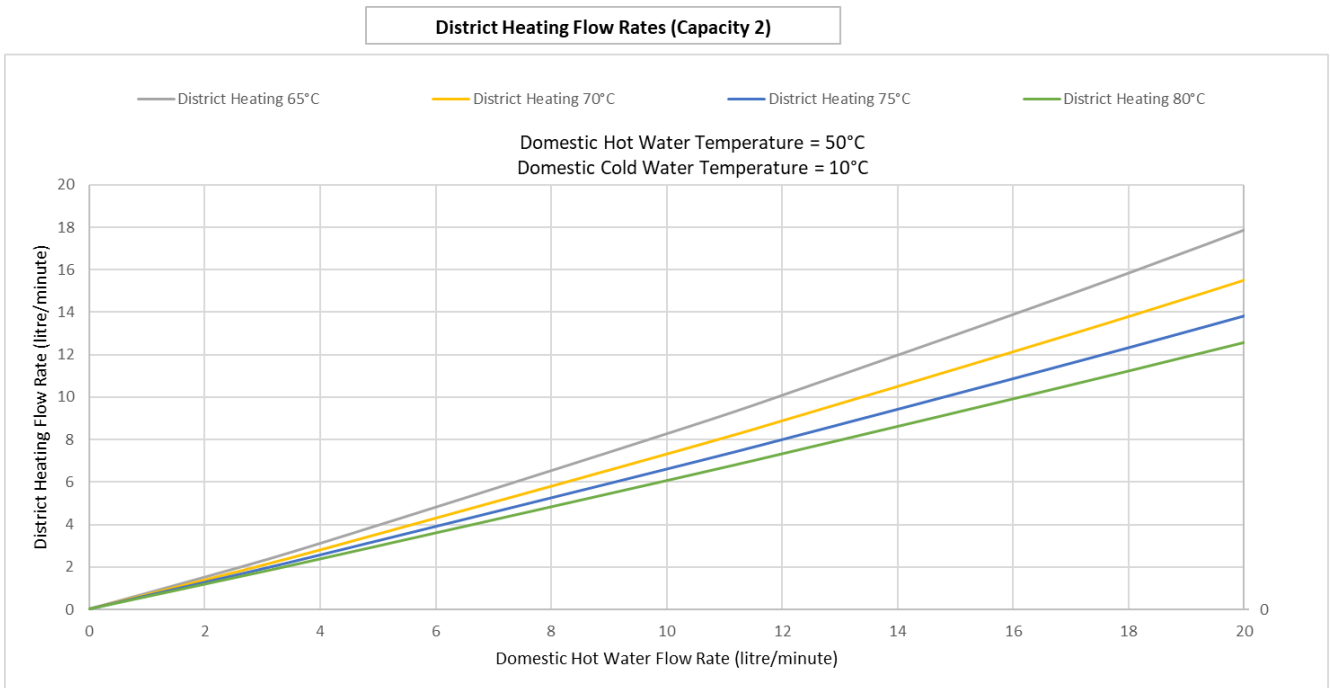

4.4 District Heating Return Temperatures (Capacity 2)

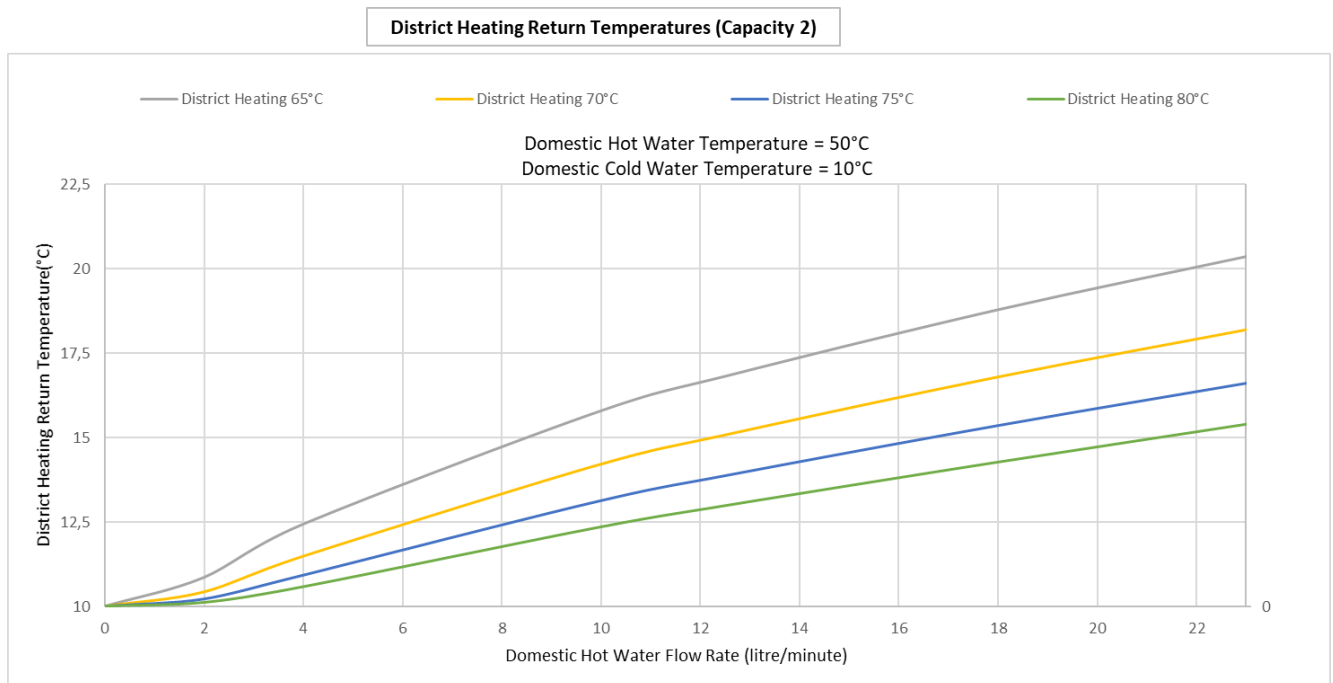

Direct SmartHexa RH

4. Performance Curves

4.5 District Heating Flow Rates (Capacity 3)

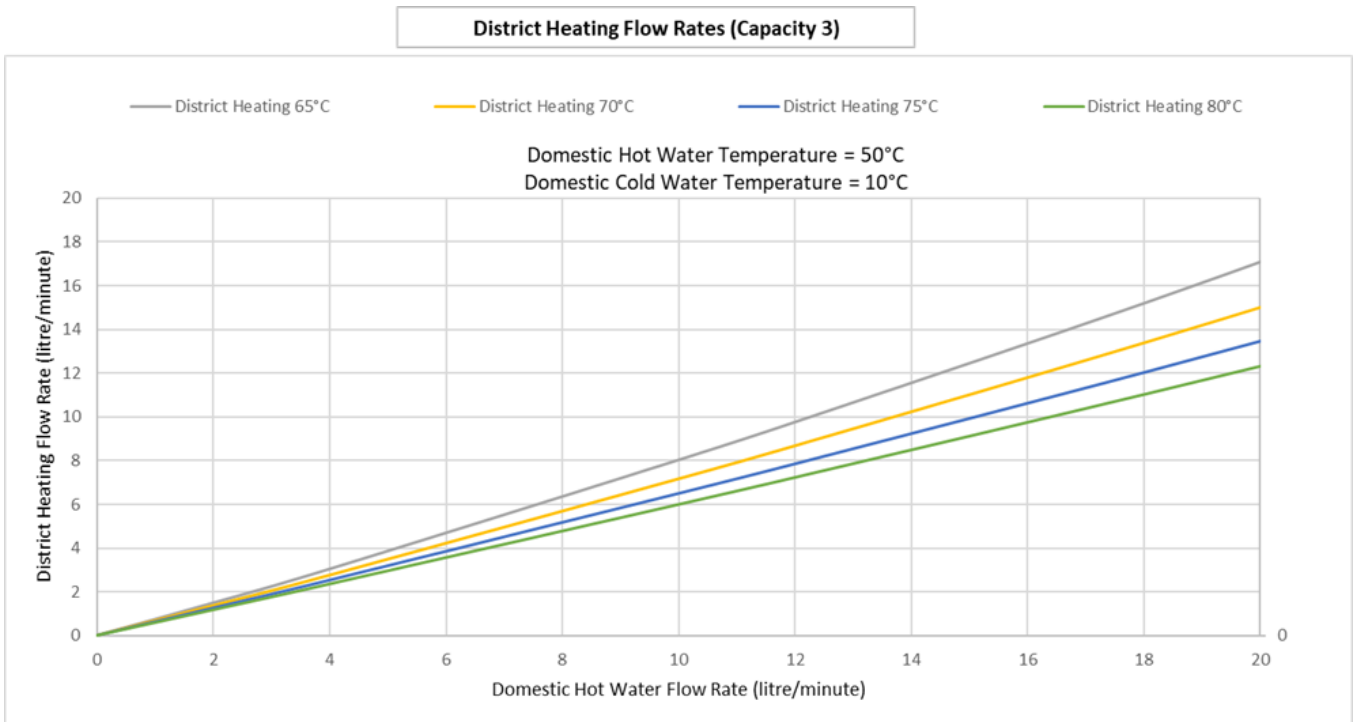

4.6 District Heating Return Temperatures (Capacity 3)

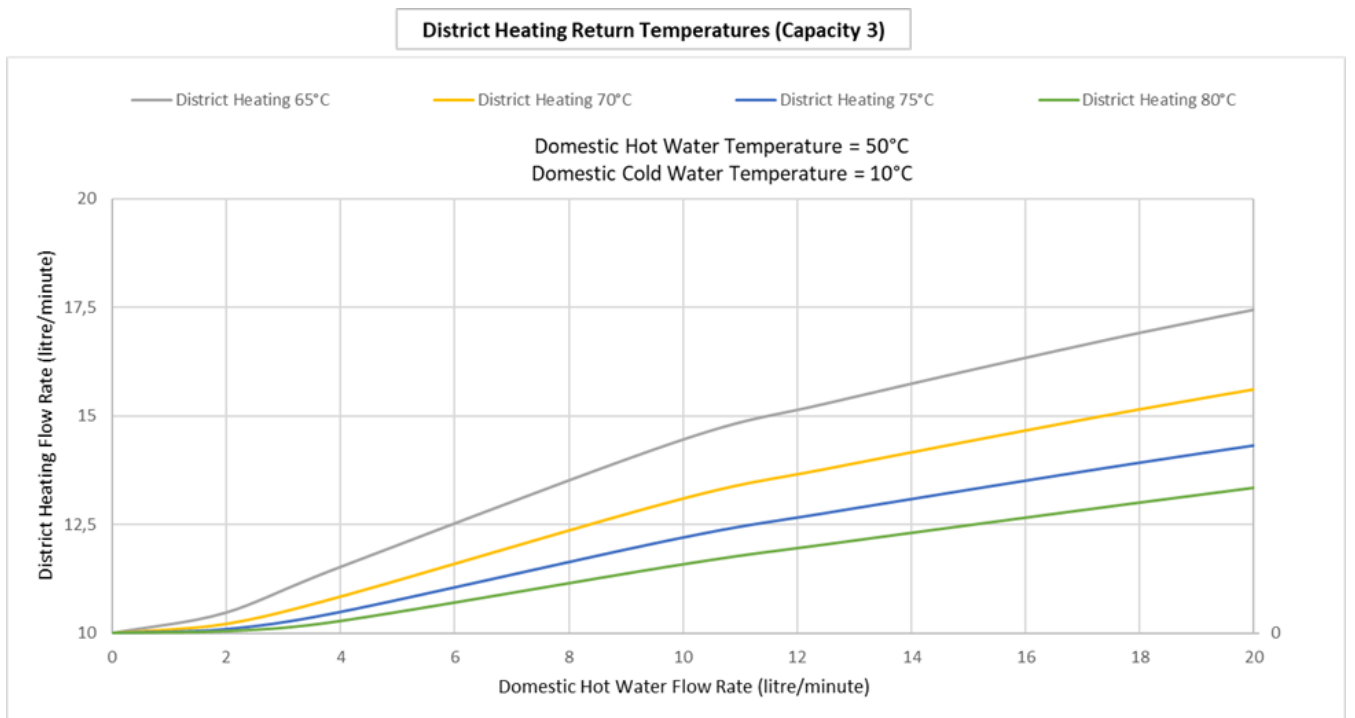

Direct SmartHexa RH

4. Performance Curves

4.7 District Heating Flow Rates (Capacity 4)

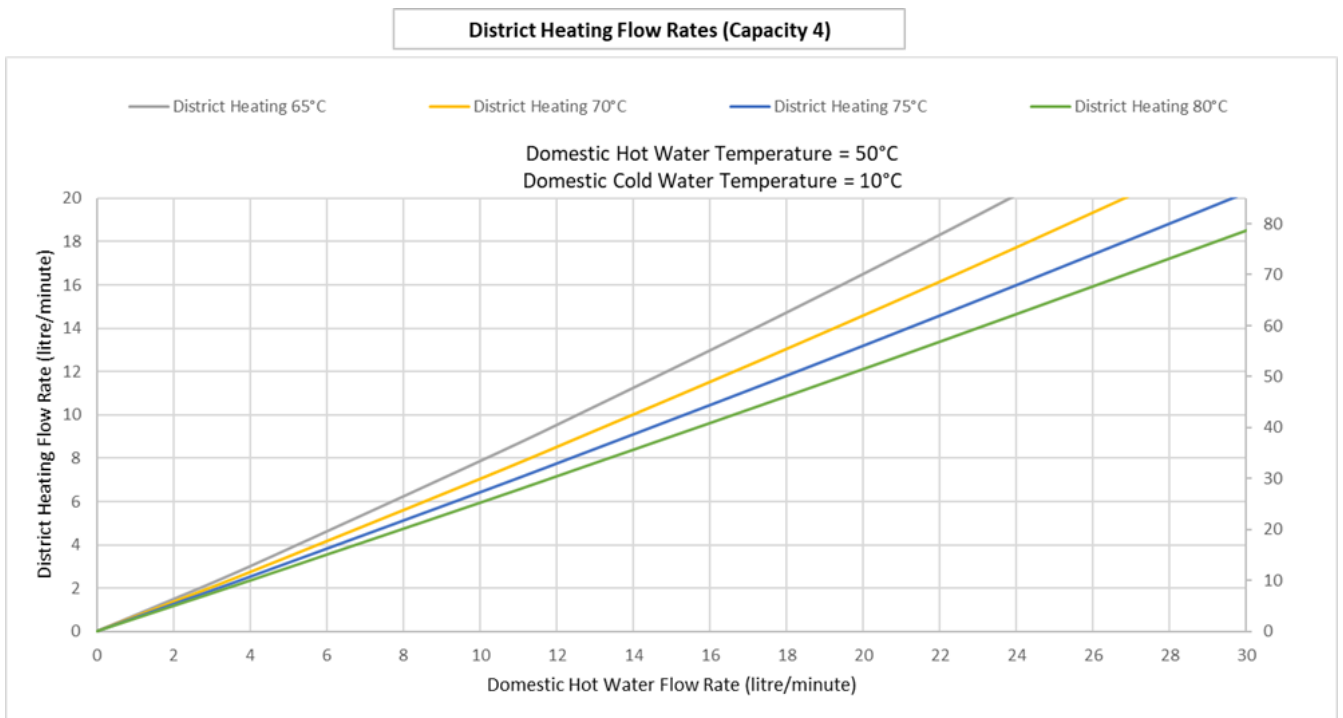

4.8 District Heating Return Temperatures (Capacity 4)

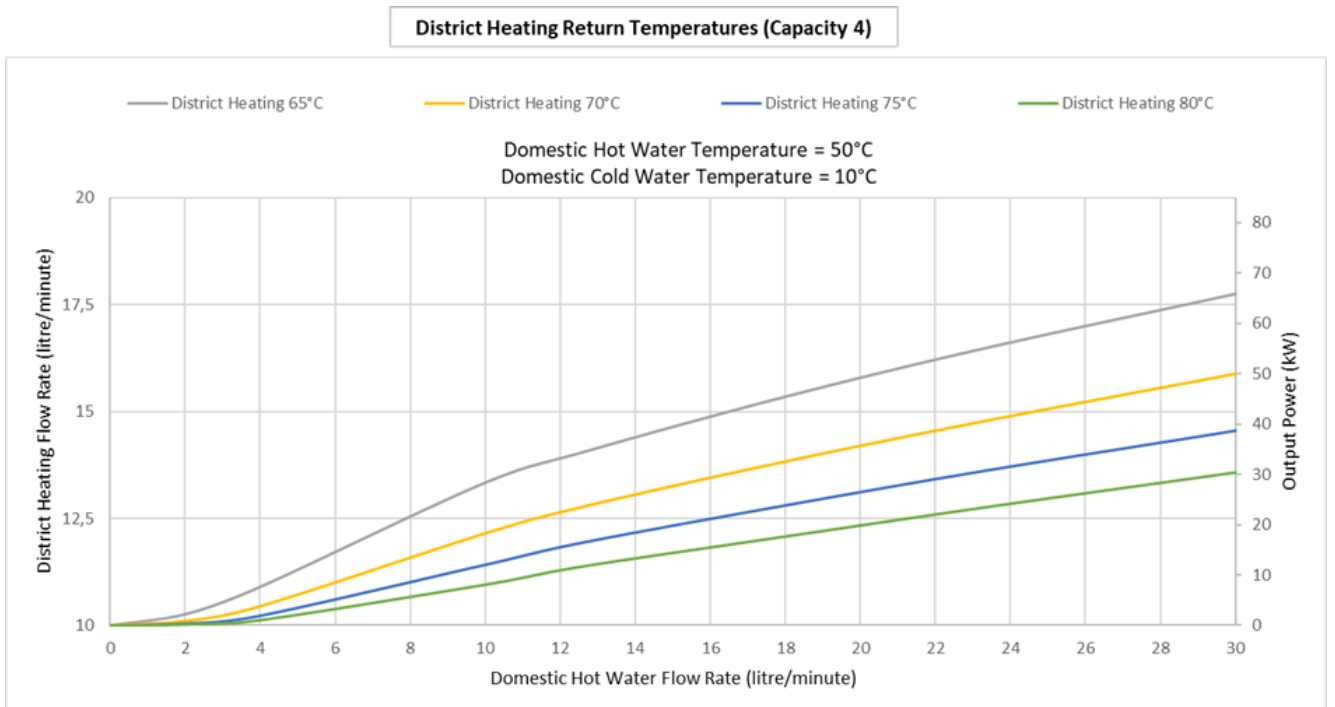

Direct SmartHexa RH

5. Performance Table

5.1 Capacity 1

HIU Performance of DHW Capacity 1					
Hot Water Output	Primary Flow °C	Capacity (kW)	DHW Flow Rate (l/m)	Primary Return °C	Primary Flow Rate (l/min)
10-50°C	55	5,5	1,983	15,36	2,021
		11	3,966	19,29	4,487
		27,5	9,915	24,54	13,15
		35	12,62	26,25	17,73
	60	5,5	1,983	12,53	1,692
		11	3,966	15,47	3,608
		27,5	9,915	19,78	9,986
		35	12,62	21,27	13,2
	65	5,5	1,983	11,31	1,5
		11	3,966	13,41	3,122
		27,5	9,915	17,08	8,404
		35	12,62	18,38	10,99
	70	5,5	1,983	10,71	1,362
		11	3,966	12,21	2,795
		27,5	9,915	15,31	7,384
		35	12,62	16,43	9,594
	75	5,5	1,983	10,39	1,254
		11	3,966	11,46	2,55
		27,5	9,915	14,06	6,646
		35	12,62	15,04	8,596
80	5,5	1,983	10,21	1,164	
	11	3,966	10,98	2,354	
	27,5	9,915	13,14	6,076	
	35	12,62	14	7,833	

Direct SmartHexa RH

5. Performance Table

5.2 Capacity 2

HIU Performance of DHW Capacity 2					
Hot Water Output	Primary Flow °C	Capacity (kW)	DHW Flow Rate (l/m)	Primary Return °C	Primary Flow Rate (l/min)
10-50°C	55	5,5	1,983	14,18	1,963
		11	3,966	17,75	4,301
		27,5	9,915	22,72	12,41
		35	12,62	24,27	16,59
		50	18,03	26,83	25,86
	60	5,5	1,983	11,8	1,667
		11	3,966	14,13	3,503
		27,5	9,915	18,23	9,616
		35	12,62	19,54	12,63
		50	18,03	21,77	19,1
	65	5,5	1,983	10,85	1,488
		11	3,966	12,42	3,063
		27,5	9,915	15,76	8,178
		35	12,62	16,87	10,65
		50	18,03	18,81	15,85
	70	5,5	1,983	10,42	1,356
		11	3,966	11,47	2,76
		27,5	9,915	14,18	7,235
		35	12,62	15,12	9,365
		50	18,03	16,81	13,8
	75	5,5	1,983	10,21	1,25
		11	3,966	10,91	2,528
		27,5	9,915	13,1	6,543
		35	12,62	13,9	8,435
		50	18,03	15,36	12,35
80	5,5	1,983	10,11	1,163	
	11	3,966	10,57	2,34	
	27,5	9,915	12,33	6,003	
	35	12,62	13,01	7,717	
	50	18,03	14,28	11,24	

Direct SmartHexa RH

5. Performance Table

5.3 Capacity 3

HIU Performance of DHW Capacity 3					
Hot Water Output	Primary Flow °C	Capacity (kW)	DHW Flow Rate (l/m)	Primary Return °C	Primary Flow Rate (l/min)
10-50°C	55	5,5	1,983	13,02	1,908
		11	3,966	15,83	4,091
		27,5	9,915	20,72	11,69
		35	12,62	22,08	15,49
		50	18,03	24,35	23,76
		65	23,43	26,22	32,89
	60	5,5	1,983	11,14	1,644
		11	3,966	12,83	3,406
		27,5	9,915	16,6	9,255
		35	12,62	17,7	12,08
		50	18,03	19,59	18,07
		65	23,43	21,22	24,48
	65	5,5	1,983	10,47	1,477
		11	3,966	11,51	3,012
		27,5	9,915	14,42	7,961
		35	12,62	15,32	10,32
		50	18,03	16,92	15,23
		65	23,43	18,32	20,39
	70	5,5	1,983	10,21	1,351
		11	3,966	10,83	2,73
		27,5	9,915	13,07	7,093
		35	12,62	13,81	9,147
		50	18,03	15,16	13,39
		65	23,43	16,37	17,8
	75	5,5	1,983	10,09	1,248
		11	3,966	10,48	2,511
		27,5	9,915	12,18	6,447
		35	12,62	12,79	8,285
		50	18,03	13,93	12,06
		65	23,43	14,98	15,95
80	5,5	1,983	10,04	1,161	
	11	3,966	10,27	2,33	
	27,5	9,915	11,57	5,936	
	35	12,62	12,07	7,61	
	50	18,03	13,02	11,03	
	65	23,43	13,94	14,53	

Direct SmartHexa RH

5. Performance Table

5.4 Capacity 4

HIU Performance of DHW Capacity 4					
Hot Water Output	Primary Flow °C	Capacity (kW)	DHW Flow Rate (l/m)	Primary Return °C	Primary Flow Rate (l/min)
10-50°C	55	5,5	1,983	12,12	1,869
		11	3,966	14,29	3,936
		27,5	9,915	18,99	11,12
		35	12,62	20,17	14,64
		50	18,03	22,16	22,18
		65	23,43	23,8	30,35
		85	30,65	25,67	42,21
	60	5,5	1,983	10,7	1,629
		11	3,966	11,87	3,338
		27,5	9,915	15,24	8,974
		35	12,62	16,16	11,66
		50	18,03	17,76	17,29
		65	23,43	19,12	23,22
		85	30,65	20,72	31,61
	65	5,5	1,983	10,26	1,471
		11	3,966	10,89	2,977
		27,5	9,915	13,31	7,791
		35	12,62	14,06	10,06
		50	18,03	15,36	14,75
		65	23,43	16,51	19,63
		85	30,65	17,88	26,42
	70	5,5	1,983	10,1	1,348
		11	3,966	10,44	2,712
		27,5	9,915	12,13	6,979
		35	12,62	12,78	8,983
		50	18,03	13,84	13,07
		65	23,43	14,8	17,29
		85	30,65	15,99	23,11
	75	5,5	1,983	10,04	1,247
		11	3,966	10,22	2,501
		27,5	9,915	11,4	6,369
		35	12,62	11,94	8,175
		50	18,03	12,81	11,84
		65	23,43	13,63	15,6
		85	30,65	14,64	20,74
	80	5,5	1,983	10,02	1,161
		11	3,966	10,12	2,325
		27,5	9,915	10,94	5,882
		35	12,62	11,38	7,535
		50	18,03	12,08	10,87
		65	23,43	12,77	14,28
		85	30,65	13,65	18,92

Direct SmartHexa RH

6. Options

Decorative Steel Cover

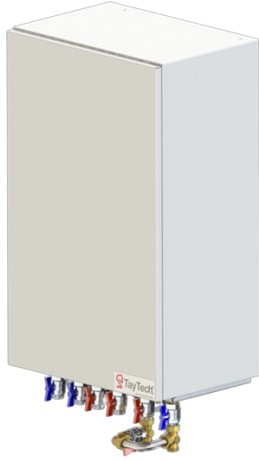

DHW Re-Circulation Kit

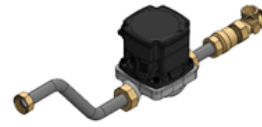

Junction Box



Pre-Plumbing Brackets
for Easy Assembly

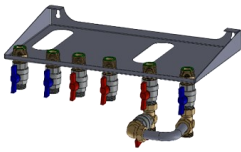

Water Hammer Arrester



Heat Meter



Flushing By-Pass Kit

